

Article number: 2082266M12B

Description: E+G Mini indexing plunger
with/without rest position, GN 822.6-6-M12-B

Measures

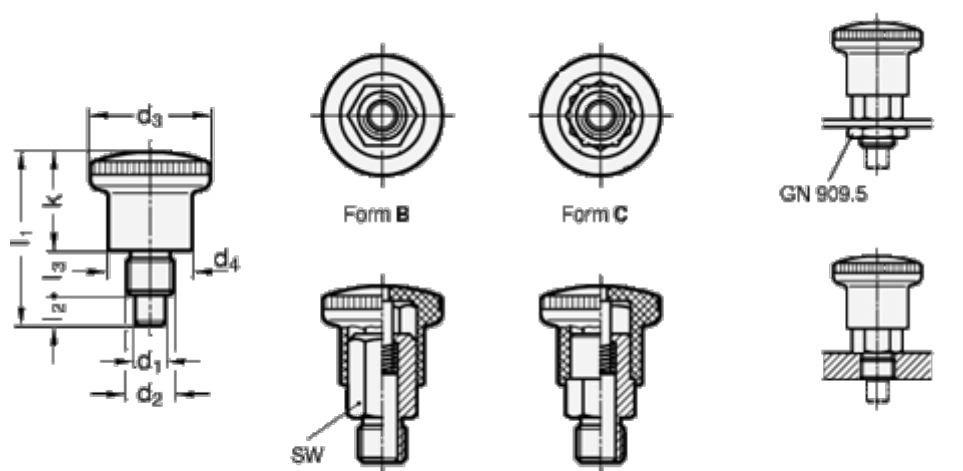

d1 = 6

d2 = M12

d3 = 28

d4 = 20

k = 23.5

l1 = 40.5

l2 = 7

l3 = 10

Spring load initial N = 10